

## Assembly of the anti-kink spring for the Zelup®Gun

### Tubes assembly and disassembly on the Zelup® fitting:

#### Surface and geometric tube characteristics

To guarantee the tubes seal with the fitting it is necessary to do the following. The tube that goes inside the fitting along the whole insert length L (table below) should not be damaged, have any cuts, scratches or burr.

The angle between the tube and the fitting should not be greater than 5°. In order to guarantee a proper seal, it is recommended that you use the adequate tube cutting tool.

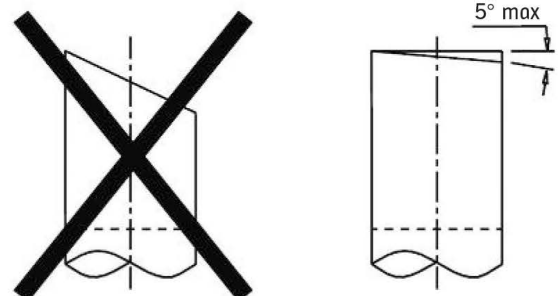
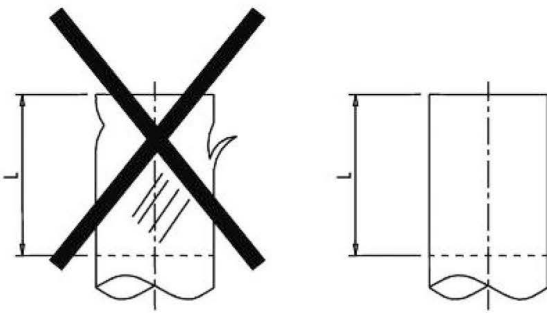

Tube cutting tool

Tube outer/inner diameter	Insert length L (mm)
4/2	9,5
6/4	9,5
8/6	9,5
10/8	11
12/9	11
15/12	11,5
16/13	13
18/14	13

Tube assembly and disassembly :

The tube assembly and disassembly must be done by an expert technician who knows exactly how the fittings have been made.

The tube needs to be inserted in the fitting up to the insert stop for the whole length H (table below). It is recommended that you mark the tube to indicate that it has been fully inserted into the fitting.

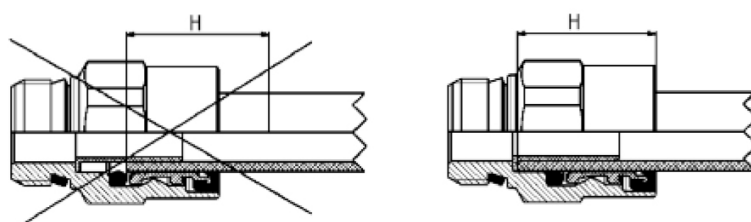

Tube outer/inner diameter	Assembly length H (mm)
4/2	18,5
6/4	18
8/6	19,5
10/8	22
12/9	21
15/12	25
16/13	27,5
18/14	27,5

To disconnect the tube it is necessary to push the fitting protection cap with the use of a special tool (see below). First make sure no air is present inside, then press the protection cap in towards the fitting body, remove the tube from the fitting.



Tool to push the fitting protection

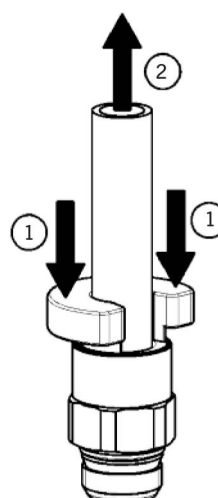

## Assembly of the anti-kink spring for the Zelup<sup>®</sup>Gun

1. Strip 15 cm off the green covering cable with stripping pliers. The use of a cutter is not recommended as it can damaged the tubes inside the covering cable.

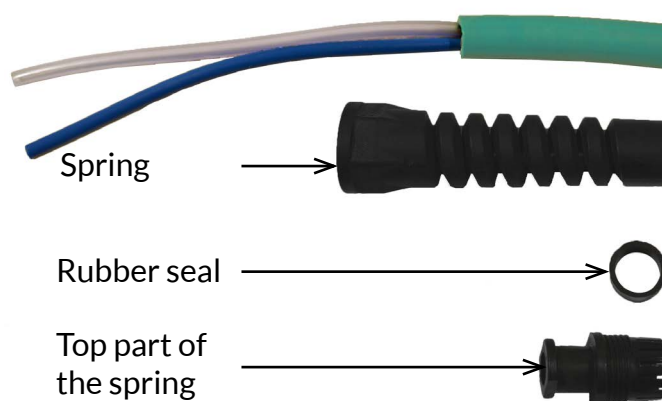
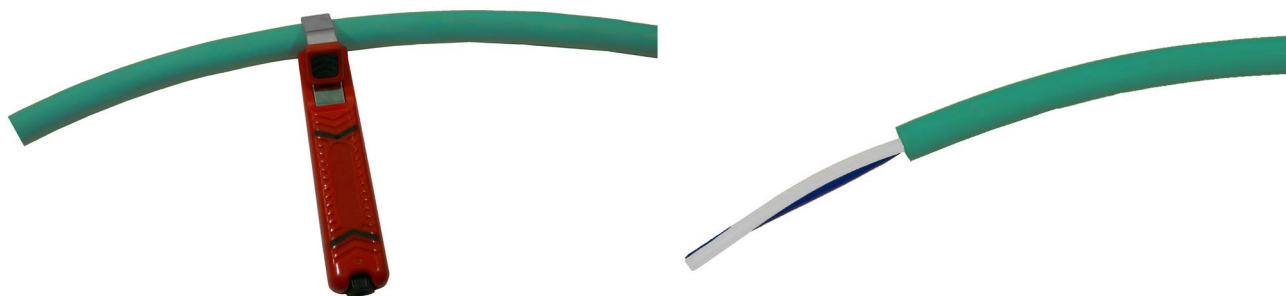

2. Screw the anti-kink spring around the hose .



3. Put the rubber seal at the end of the hose with a margin of 3mm (see below).

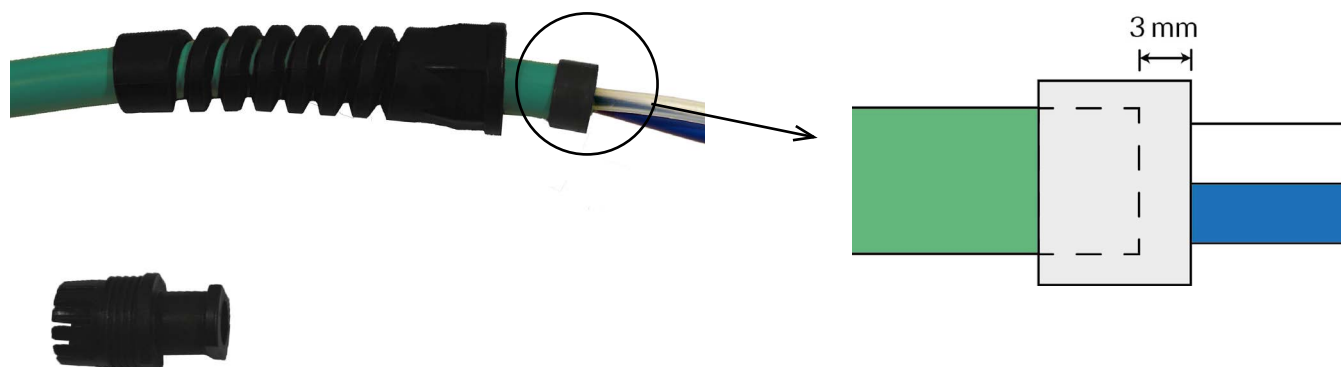

4. Put the top part of the anti-kink spring around the rubber seal and cover it completely.



5. Put special glue for plastics materials on the screw thread of the top part of the spring. Move the anti-kink spring up along the hose and screw it around the top part. Your hose is ready for use.



Zelup® Sas  
38, rue de l'université  
69007 - Lyon  
France

Service après-vente  
[www.zelup.golf](http://www.zelup.golf)  
Contact section